

**Metl-Span CF-42 HPCI Wall Panels**  
**26 Ga. Exterior / 26 Ga. Interior Facings**  
**Allowable Connection Load<sup>1,7,8,9,10</sup> (psf) for Two or More Equal Spans**

Panel Type <sup>2</sup>	Design Criteria <sup>3,4,5,6</sup>	Support Span										
		5 ft	6 ft	7 ft	8 ft	9 ft	10 ft	11 ft	12 ft	13 ft	14 ft	15 ft
2" Thick	Connection FP1	31.3	25.6	21.6	18.7	16.5	14.7	13.3	12.1	11.1	10.3	9.6
	Connection FP2	45.8	37.5	31.6	27.3	24.1	21.5	19.4	17.7	15.1	12.9	11.1
	Connection FP3	57.9	47.3	39.9	34.5	30.3	25.1	21.0	17.8	15.1	12.9	11.1
2½" Thick	Connection FP1	33.1	27.0	22.8	19.7	17.3	15.4	13.9	12.7	11.7	10.8	10.0
	Connection FP2	47.2	38.5	32.5	28.0	24.7	22.0	19.9	18.1	16.6	15.4	14.3
	Connection FP3	59.7	48.7	41.1	35.5	31.2	27.8	25.1	22.9	21.0	17.8	15.2
3" Thick	Connection FP1	34.9	28.5	24.0	20.7	18.2	16.2	14.6	13.3	12.2	11.3	10.5
	Connection FP2	48.5	39.6	33.4	28.8	25.3	22.5	20.3	18.5	17.0	15.7	14.6
	Connection FP3	61.5	50.2	42.3	36.5	32.0	28.6	25.8	23.4	21.5	19.9	17.7
	Connection FP4	70.6	57.7	48.6	41.9	36.8	32.8	29.6	27.0	24.7	20.8	17.7
4" Thick	Connection FP1	42.9	35.1	29.6	25.5	22.4	19.9	17.9	16.3	14.9	13.8	12.8
	Connection FP2	62.9	51.5	43.4	37.4	32.8	29.2	26.3	23.9	21.9	20.2	18.8
	Connection FP3	74.2	60.7	51.2	44.1	38.7	34.4	31.0	28.2	25.8	23.8	22.1
	Connection FP4	79.5	65.0	54.8	47.2	41.4	36.9	33.2	30.2	27.7	25.5	23.7
	Connection FP5	83.2	68.0	57.3	49.4	43.4	38.6	34.7	31.6	29.0	26.7	24.8
	Connection FP9	89.4	73.1	61.6	53.1	46.6	41.5	37.3	34.0	31.1	28.7	26.7
	Connection FP10	93.5	76.5	64.5	55.6	48.7	43.4	39.1	35.5	32.6	30.1	27.2

**Notes:**

- The Load Span Table above is based on Allowable Stress Design (ASD). For loads calculated based on ASCE 7-10 (LRFD), please refer to section 2.4.1 of ASCE 7-10 for the applicable load combinations using Allowable Stress Design.
- Based on CF-42 panel with 26 ga. Light Mesa exterior and 26 ga. Light Mesa interior face (min  $F_y = 33$  ksi).
- Fastener pattern FP1 is based on CF panel clips fastened to min. 14 ga. steel. Fastener options will be (2) ¼"-14 SDS Type 3, (2) ¼"-14 Self-Tapping, (2) ¼"-14 Type 5 SDS, (2) ¼"-20 Type 5 SDS, or (2) ¼"-28 Type 5 SDS. Fastener selection will be based on fastener pullout capacity from support steel members.
- The fastener patterns FP2, FP3, FP4, and FP5 include FP1 plus 1, 2, 3, and 4 blind rivets, respectively, at supports per panel width. Blind Rivet spacing is 10.5" o.c. from female edge of panel seam.
- The through fasteners (FP9) are as follows: Panels fastened to min. 14 ga. steel supports with (4) ¼"-14 SDS Type 3, (4) ¼"-14 Self-Tapping, (4) ¼"-14 Type 5 SDS, (4) ¼"-20 Type 5 SDS, or (4) ¼"-28 Type 5 SDS with nominal 5/8" diameter neoprene bonded washers spaced at 8.4" o.c. Fastener shall be of sufficient length to penetrate through the support a minimum of ¾". Fastener selection will be based on fastener pullout capacity from support steel members.
- The through fasteners (FP10) are as follows: Panels fastened to min. 14 ga. steel supports with (5) ¼"-14 SDS Type 3, (5) ¼"-14 Self-Tapping, (5) ¼"-14 Type 5 SDS, (5) ¼"-20 Type 5 SDS, or (5) ¼"-28 Type 5 SDS with nominal 5/8" diameter neoprene bonded washers spaced at 8.4" o.c. Fastener shall be of sufficient length to penetrate through the support a minimum of ¾". Fastener selection will be based on fastener pullout capacity from support steel members.
- Allowable positive or suction load is the lowest value of panel bending strength, shear strength, deflection limit and connection strength for each fastener pattern.
- Allowable loads based on panel stress and deflection design criteria are derived from ASTM E72 structural testing and calculated with factor of safety of 2.5 for bending stress, 3.0 for shear stresses and deflection limitation of  $L/180$ .
- The panel connection strength was determined from ASTM E1592 testing and the allowable loads are calculated with factor of safety of 2.
- The structural capacity of the purlins are not considered and must be examined independently.

**Metl-Span HPCI Wall Panels<sup>7</sup>**  
**26 Ga. Exterior / 26 Ga. Interior Facings**  
**Allowable Positive Load<sup>1,4,5,6</sup> (psf) for Two or More Equal Spans**

Panel Type <sup>2</sup>	Design Criteria <sup>3</sup>	Support Span										
		5 ft	6 ft	7 ft	8 ft	9 ft	10 ft	11 ft	12 ft	13 ft	14 ft	15 ft
2" Thick	Bending & Shear	70.6	58.1	49.4	42.7	37.6	30.6	24.4	20.0	16.7	14.1	12.2
	Deflection (L/180)	72.1	56.5	45.4	36.8	30.3	25.1	21.0	17.8	15.1	12.9	11.1
2½" Thick	Bending & Shear	80.3	66.0	56.1	48.7	42.8	38.2	31.3	25.4	21.1	17.8	15.2
	Deflection (L/180)	90.1	71.3	58.0	48.0	40.0	33.7	28.6	24.5	21.0	18.2	15.8
3" Thick	Bending & Shear	89.2	73.3	62.1	53.9	47.6	42.4	37.2	30.0	24.8	20.8	17.7
	Deflection (L/180)	106.2	84.7	69.4	58.0	49.1	41.8	35.9	31.0	26.9	23.5	20.6
4" Thick	Bending & Shear	94.4	77.4	65.5	56.7	50.0	44.7	40.5	36.8	33.7	31.1	27.2
	Deflection (L/180)	132.8	107.0	88.5	74.7	64.0	55.5	48.5	42.5	37.5	33.2	29.5

**Notes:**

1. The Load Span Table above is based on Allowable Stress Design (ASD). For loads calculated based on ASCE 7-10 (LRFD), please refer to section 2.4.1 of ASCE 7-10 for the applicable load combinations using Allowable Stress Design.
2. Based on CF-panel with 26 ga. Light Mesa exterior and 26 ga. Light Mesa interior face (min  $F_y = 33$  ksi).
3. Refer to the allowable connection load chart, for suction loads.
4. Allowable positive or suction load is the lowest value of panel bending strength, shear strength, deflection limit and connection strength for each fastener pattern.
5. Allowable loads based on panel stress and deflection design criteria are derived from ASTM E72 structural testing and calculated with factor of safety of 2.5 for bending stress, 3.0 for shear stresses and deflection limitation of L/180.
6. The structural capacity of the purlins are not considered and must be examined independently.
7. Consult Metl-Span for recommendations on panel profile and gauge suitable for thermal stresses.



SUPPORT  
(NOT BY METL-SPAN)

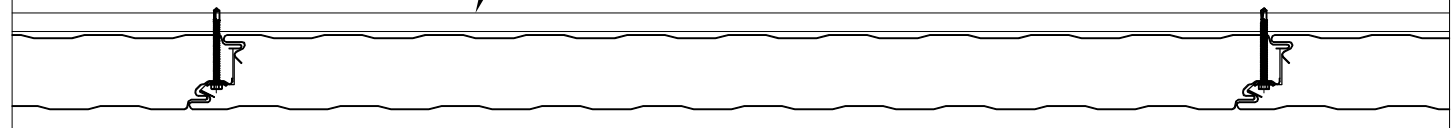

(FP1) SIDE JOINT CLIP ONLY

FROM FEMALE  
EDGE (CRITICAL)

SUPPORT  
(NOT BY METL-SPAN)

10.5"

10.5"

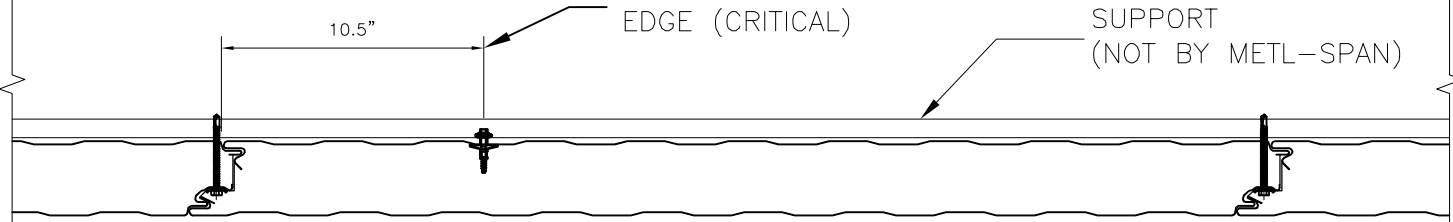

(FP2) SIDE JOINT AND (1) BLIND RIVET

SUPPORT  
(NOT BY METL-SPAN)

10.5"

10.5"

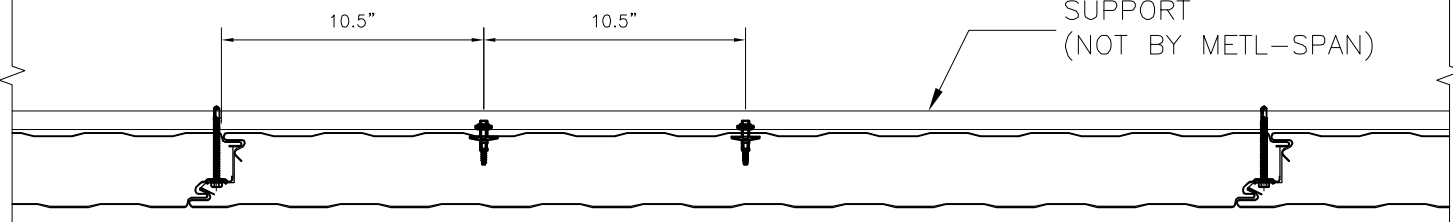

(FP3) SIDE JOINT AND (2) BLIND RIVETS

SUPPORT  
(NOT BY METL-SPAN)

10.5"

10.5"

10.5"

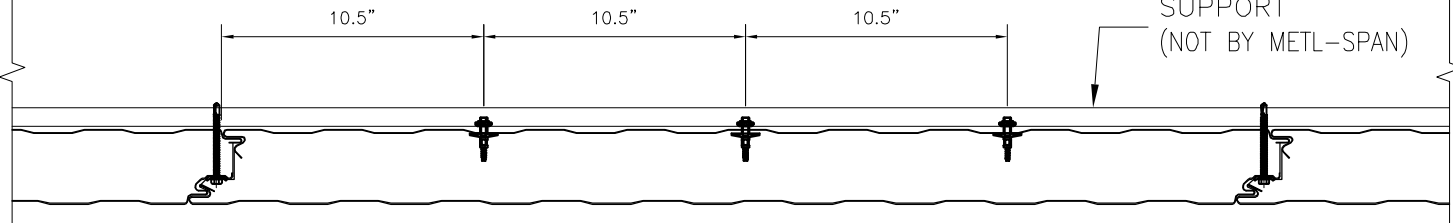

(FP4) SIDE JOINT AND (3) BLIND RIVETS

# CF42 FASTENING PATTERNS

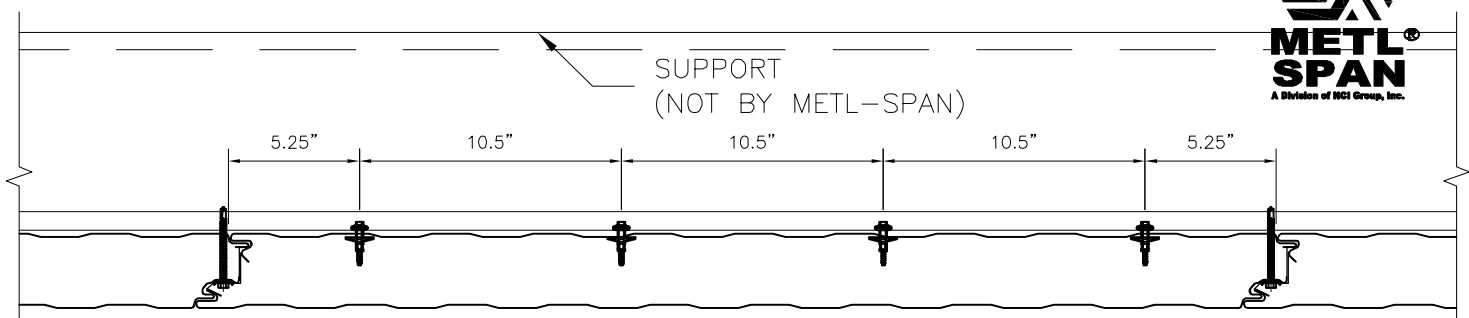

(FP5) SIDE JOINT AND (4) BLIND RIVETS

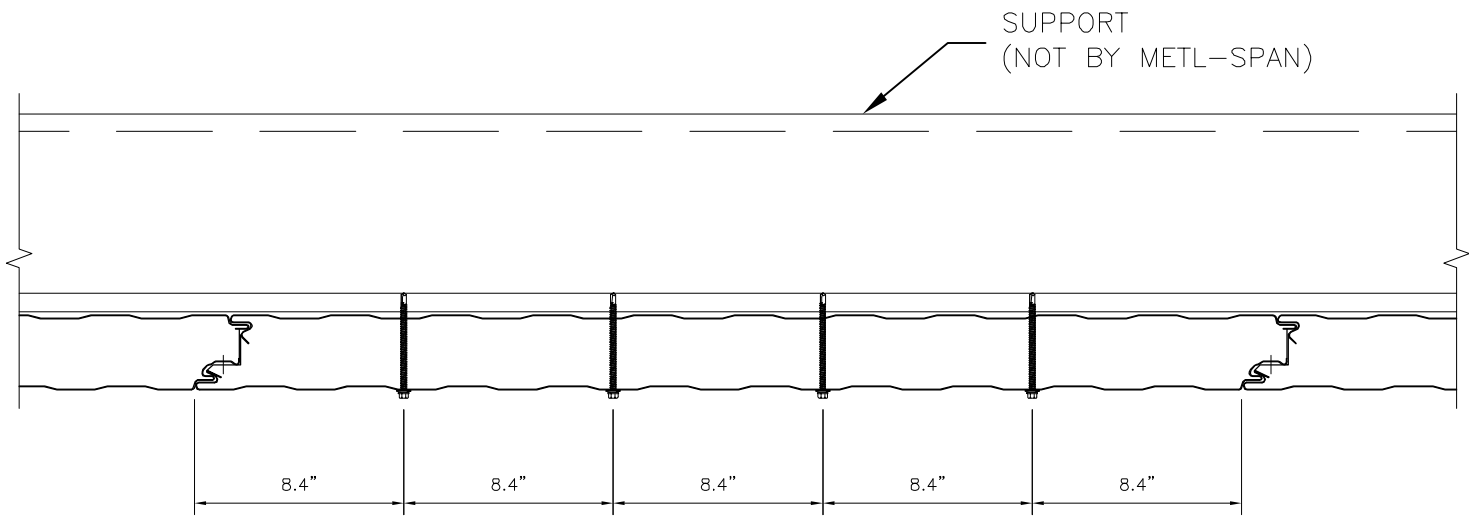

(FP9) (4) SELF-DRILLING OR SELF-TAPPING FASTENERS W/ NEOPRENE BONDED WASHER

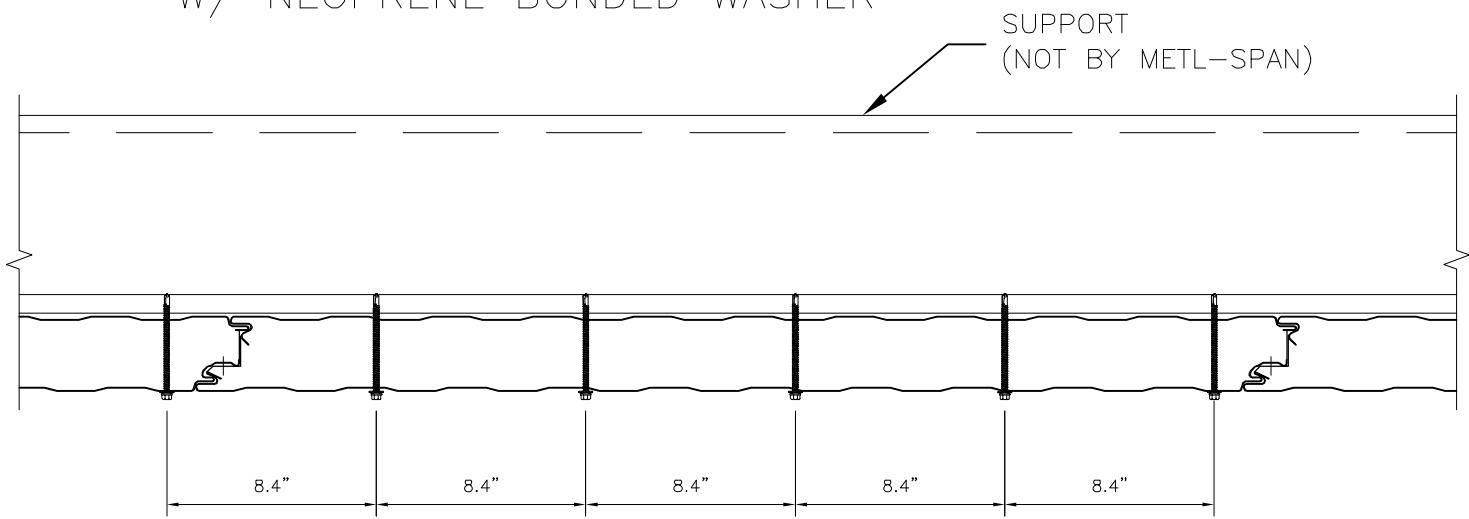

(FP10) (5) SELF-DRILLING OR SELF-TAPPING FASTENERS W/ NEOPRENE BONDED WASHER

# CF42 FASTENING PATTERNS

<b>FASTENING PATTERNS</b>	<b>APPLICATION: FASTENING</b>	<b>2 of 2</b> DATE: MAY 15, 2015
---------------------------	-----------------------------------	-------------------------------------